



OPERATING GUIDE

WLAN TRANSCEIVER
IP110H

INTRODUCTION

1 BEFORE USING

2 BASIC OPERATION

3 ADVANCED OPERATION

4 MENU SCREEN

5 OPTIONS

6 FOR YOUR REFERENCE

INTRODUCTION

Thank you for choosing this Icom product.
This product is designed and built with Icom's state of the art technology and craftsmanship.
With proper care, this product should provide you with years of trouble-free operation.

IMPORTANT

FIRST, CAREFULLY READ INSTRUCTIONS that is included with the transceiver.

SAVE THIS OPERATING GUIDE— This operating guide contains additional important operating instructions for the transceiver.

NOTE:

- This operating guide is based on the IP110H Version 1.09.
 - The explanations in this guide assume that the registration on the Controller* has been completed. Ask your system manager for details.
- * As of September 2022, the IP1000C, IP1100CV, and VE-PG4 can be used as the controller of the IP110H. In this guide, the IP1000C, IP1100CV, and VE-PG4 are written as "Controller."

FEATURES

- Complies with the IEEE802.11 n/a/b/g/ac standards.
- Transmits and receives voice and text messages*¹ through the wireless LAN access points installed in the IP network, using the Controller.
- Displays the status*¹ transmitted by the IP110H on the screen of the Controller and the IP100FS.
- 2 types of communication, the Full Duplex mode and the Simplex mode.*²
- Waterproof and Dust-Tight Durable Design. (IP67/IP54)

*¹ The text message and status you can transmit depend on the Controller settings.

*² Full Duplex mode: Simultaneously transmits and receives like a telephone.

Simplex mode: Transmits (Talker) or receives (Listener). Users have to take turns to communicate.

DO NOT OPEN, JOLT, SHORT, OR INCINERATE, AS THE BATTERY MAY IGNITE OR BURST.

Icom is not responsible for the destruction, damage to, or performance of any Icom or non-Icom equipment, if the malfunction is because of:

- Force majeure, including, but not limited to, fires, earthquakes, storms, floods, lightning, other natural disasters, disturbances, riots, war, or radioactive contamination.
- The use of Icom transceivers with any equipment that is not manufactured or approved by Icom.

Icom and the Icom logo are registered trademarks of Icom Incorporated (Japan) in Japan, the United States, the United Kingdom, Germany, France, Spain, Russia, Australia, New Zealand, and/or other countries.

3M, PELTOR, and WS are trademarks of 3M Company.

The Bluetooth® word mark and logos are registered trademarks owned by the Bluetooth SIG, Inc. and any use of such marks by Icom Inc. is under license.

Other trademarks and trade names are those of their respective owners.

Section 1 BEFORE USING

Attaching the belt clip	1-2
Battery charging	1-2
Turning ON the transceiver	1-3
Adjusting audio output level.....	1-3
Panel description	1-4
Operating keys	1-4
Function display.....	1-5
Battery warning beeps.....	1-6
Key Lock function	1-6

1 BEFORE USING

Attaching the belt clip

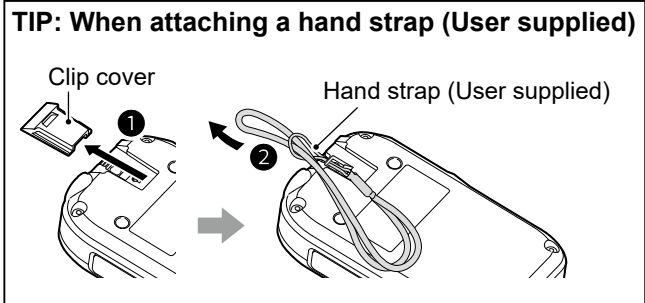
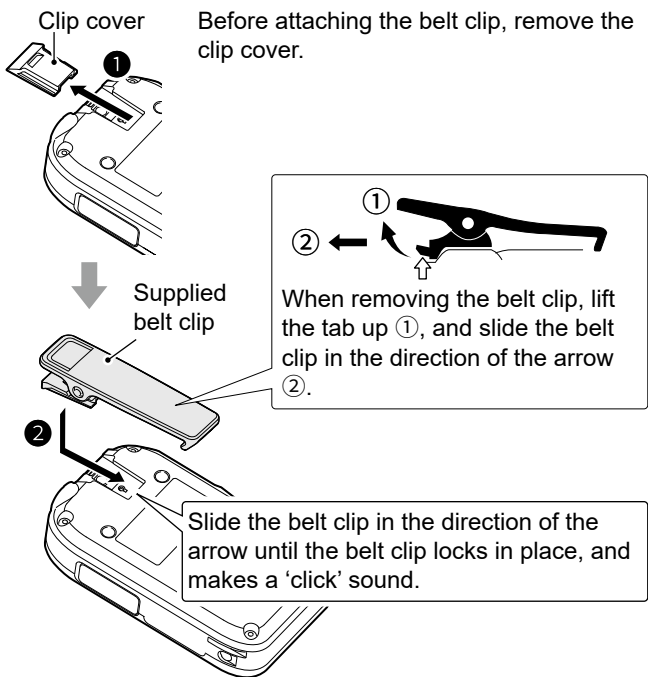

Battery charging

Fully charge the transceiver before using for the first time, or if it has not been used for more than 2 months.

- The charger automatically restarts charging when the battery voltage drops.
- Disconnect the AC adapter from the outlet when the charger is not in use.

CAUTION: Read the 'Battery caution' and 'Charging caution' on INSTRUCTIONS (supplied with the transceiver) before charging.

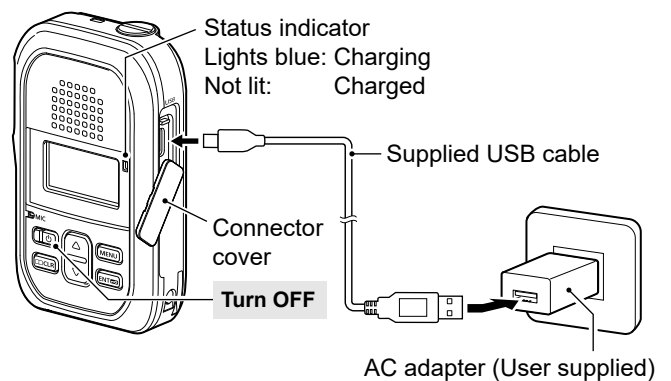

NOTE:

- Use a 5 V/2 A output AC adapter.
- The charging time may differ, depending on the AC adapter. When you use a low output AC adapter, it may take longer to charge, or the transceiver may not be charged.
- Before using the AC adapter, thoroughly read its instructions.

① You can charge up to 4 IP110Hs together by using 4 BC-257 optional chargers and the BC-228 optional AC adapter. See page 5-4 for details.

Turning ON the transceiver

- Hold down [⏻] for 2 seconds.
 - A beep sounds.

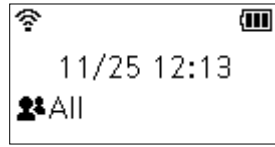
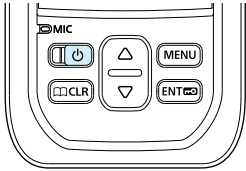

Standby screen

NOTE: The explanations in this guide assume that the registration on the Controller has been completed. If no Standby screen is displayed, ask your system manager.

- ① The signal strength is displayed in 1 to 3 levels.
A beep may sound when it goes out of, or enters into the service area, depending on the Controller setting.

Adjusting audio output level

- Push [▲]/[▼] to adjust the audio output level.
 - ① The volume can be adjusted between 0 and 32.

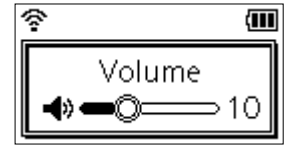
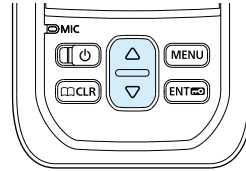

NOTE: If the output level is set to 0, the received audio and beep do not sound.

1 BEFORE USING

Panel description

NOTE: Instructions and screens on this guide may differ, depending on the Controller settings.

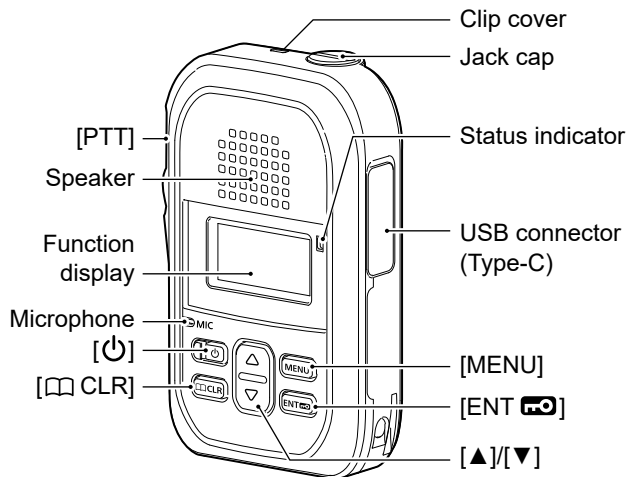

① The USB connector does not support USB Power Delivery (USB PD).

About the Status indicator

- Lights red while transmitting.
- Lights green while receiving a call.
- Lights yellow while making a call in the Full Duplex mode.

When connecting optional equipment:

- Be sure to turn OFF the transceiver before connecting or disconnecting optional equipment to or from the jack.
- Insert the plug securely when connecting the cable.
- Remove the cable by holding the plug, not the cable.

CAUTION: Attach the jack cap when no optional equipment is connected.

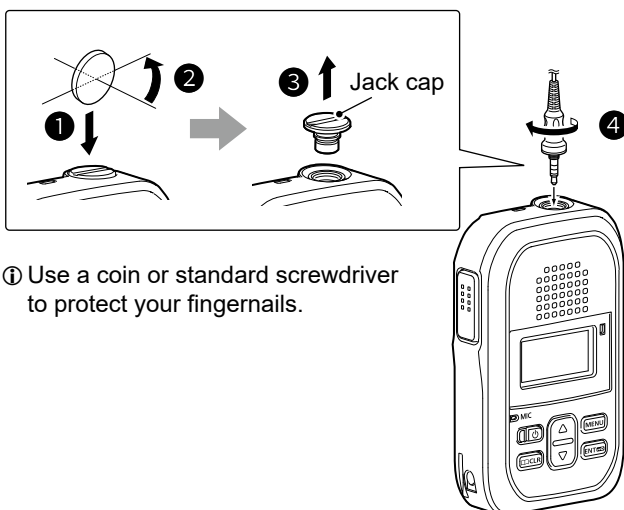

① Use a coin or standard screwdriver to protect your fingernails.

Operating keys

[PTT] switch

Hold down to transmit, release to receive.

[PTT] key

Hold down for 2 seconds to turn the transceiver ON or OFF.

[CLR] key*

- In the Standby screen, push to display the ID List screen.
① May be usable, depending on the Controller setting.
- In the MENU screen, push to return to the previous screen.

[▲]/[▼] key

- In the Standby screen, push to adjust the audio level.
- In the MENU screen, push to select a setting item or value.

[ENT] key

- In the Standby screen, hold down for 1 second to turn the Key Lock function ON or OFF.
- In the MENU screen, push to set the selected item or option.

[MENU] key*

- In the Standby screen, push to display the MENU screen.
- In the MENU screen, push to go back to the Standby screen.

* One of the functions described on page 3-9 may be assigned to the key, depending on the Controller setting. Hold down the key for 1 second to use the assigned function.

Function display

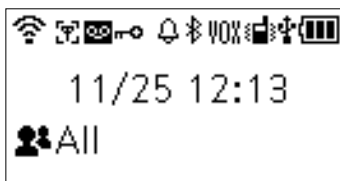

	Signal strength <ul style="list-style-type: none"> Displays the signal strength in 1 to 3 levels. “” blinks when you are out of a service area. “” is displayed if your transceiver is not registered, or not connected to the Controller.
	Area Call function* (p. 3-5) Displayed when the Area Call function is ON.
	Recording function* (p. 3-15) <ul style="list-style-type: none"> “” is displayed when the Recording function is ON. “” blinks when there is new recorded data. “” blinks while recording audio.
	Key Lock function (p. 1-6) Displayed when the Key Lock function is ON.
	Pocket Beep function* (p. 3-10) <ul style="list-style-type: none"> Displayed when the Pocket Beep function is ON. Blinks when a call is received. This icon blinks until the transceiver returns to the Standby mode after a received signal disappears.
	P-Bell function* (p. 3-10) Displayed when the P-Bell function is ON.
	Bluetooth function (p. 5-5) <ul style="list-style-type: none"> “” is displayed when the Bluetooth function is ON. “” is displayed when a Bluetooth device is connected to the transceiver.
	VOX function* (p. 3-10) Displayed when the VOX function is ON.
	Receive-only* Displayed when transmission is inhibited.

	Vibration function* Displayed when the Vibration function is ON.
	Mute function* (p. 3-9) Displayed when the audio is muted.
	USB connection Displayed when a USB device is connected through a USB cable.
	Remaining battery capacity <ul style="list-style-type: none"> Displays the remaining capacity in 4 steps. : The battery has sufficient capacity. : The battery is a little exhausted. : The battery is nearing exhaustion. (Charging is necessary.) : The battery is almost fully exhausted. (Charging is required.) “” is displayed while charging.

About the Call types

	All/Group Call
	Talkgroup Call* (pp. 3-6 ~ 3-8)
	Individual Call
	Phone Call

* May be usable, depending on the Controller setting.

An “F” blinks while updating the firmware:

- You cannot turn OFF the transceiver until the firmware download and update are finished. Place the transceiver in a good signal level area.
- The transceiver will automatically restart when the update is finished.

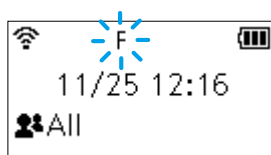

- If the “F” does not blink, restart the transceiver.
- If the battery status indication is “” (nearing exhaustion) or “” (exhausted), the firmware update will not start. Charge the battery, restart the transceiver, and then update the firmware.

Battery warning beeps

When the battery is almost exhausted, the battery status indicator “

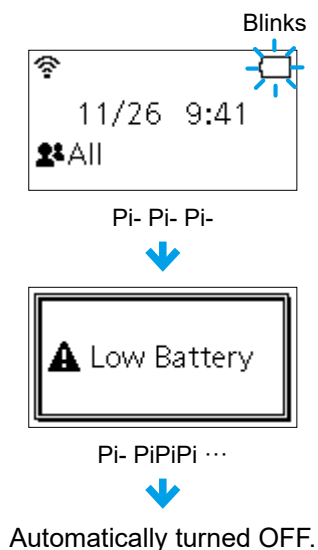

When the battery is nearly exhausted:

When “Low Battery” is displayed and beeps sound, the transceiver will automatically turn OFF soon.



Key Lock function

The Key Lock function prevents accidental function access.

- ① An Emergency call (p. 3-11) can be made, even while the Key Lock function is ON.
- Hold down [ENT ] for 1 second.
 - A beep (Pi, Pi) sounds, and “] for 1 second to turn OFF the function.
 - ① [PTT], [P], and [▲]/[▼] can be used, even while the Key Lock function is ON.

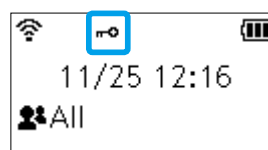

Standby screen



When a key is pushed while the Key Lock function is ON.

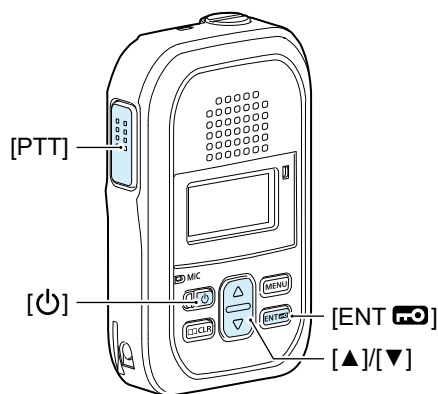

Section 2 BASIC OPERATION

Transmitting and receiving	2-2
Using the Phone Book.....	2-4
Using a Call history entry.....	2-5

Transmitting and receiving

1. Transmitting a call

While holding down [PTT], speak into the microphone at your normal voice level.

- The status indicator lights red while transmitting.

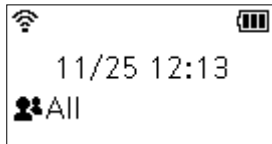

All call is selected.

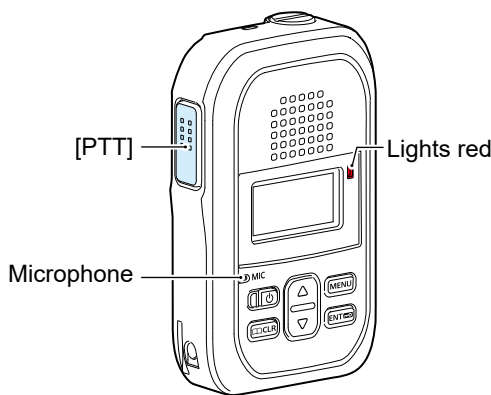

2. Receiving a call

When a call is received, the audio is heard.

- The status indicator lights green while receiving.



Receiving an All call



Calling tip:

Hold the transceiver 5 ~ 10 cm (2 ~ 4 inches) away from your mouth, and speak at your normal voice level. Talking too close to the microphone, or in a loud voice, can distort your voice.

About the Time-out Timer:

When the continuous transmission period exceeds the set period of time*, the Time-out Timer automatically stops transmission to prevent an accidental prolonged transmission.

Release [PTT], and then hold down again to resume talking.

* Depending on the Controller setting.

About the key touch beep:

A confirmation beep may sound when you push a key, depending on the Controller setting.

About the alert:

The alert that indicates that you are out of the service area, or receiving a call may sound, depending on the Controller setting.

About the Vibration function:

The Vibration function may indicate that a call is received, depending on the Controller setting.

About the Mute function:

You may be able to mute the received audio by holding down [CLR] or [MENU] for 1 second, depending on the Controller setting. (p. 3-9)

① The notification tone is not muted.

Transmitting and receiving

3. Talking while receiving a call

While receiving a call in the Full Duplex mode*, push [PTT] to talk, just like making a telephone call.

- ① In the Full Duplex mode, the status indicator lights yellow.
- ① Push [▲]/[▼] to adjust the audio output level. **DO NOT** cover the speaker or microphone.
- If howling occurs, turn down the output level.

* Depending on the Controller setting.

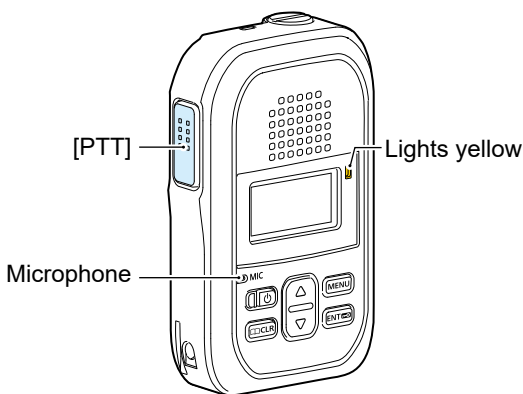

About the Simplex mode:

If the communication mode is set to Simplex, users have to take turns to communicate:

Push [PTT] to talk, release to receive.

- ① Push [PTT] after the other person finishes talking.
- ① Saying "Over" at the end of your talk makes the communication smooth.

About the Back Light function:

The Back Light function setting may differ, depending on the Controller setting.

- Always OFF: The backlight does not light.
- Always ON: The backlight lights continuously.
- On operation: When a call is received, or a key is pushed, the backlight lights, then automatically turns OFF after 5 seconds.

Turning OFF the transceiver:

Hold down [⏻] for 2 seconds.

- The last selected call-to party is saved, and then the transceiver is turned OFF.
- ① **DO NOT** turn OFF the transceiver within 2 seconds after you change the transceiver settings. Otherwise, the changed settings may be lost.

Using the Phone Book

The [CLR] key may be usable, depending on the Controller setting.

1. Selecting a call-to party from the Phone Book

1. Push [CLR].
 - ① You can also open the Phone Book in the MENU screen. (p. 4-3)
2. Push [▲]/[▼] to select a call type, and then push [ENT].
(Example: Group)
 - ① See page 3-6 about Talkgroup.
3. Push [▲]/[▼] to select a tab, and then push [ENT]. (Example: S)
4. Push [▲]/[▼] to select a call-to party, and then push [ENT].
(Example: Sales group1)

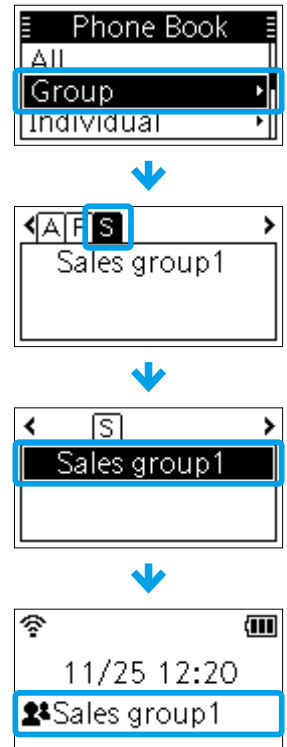
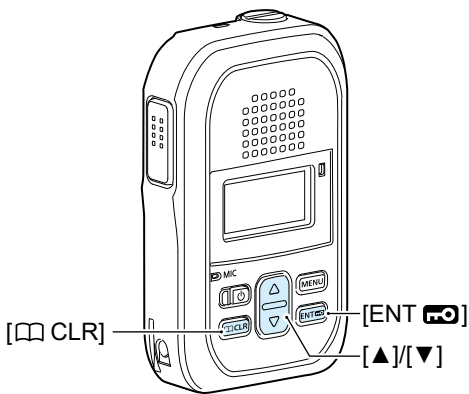

About the All or Group (Talkgroup) call:
Ask your system manager for the call type setting.

TIP: The call-to parties are displayed in the “#” tab when:

- The party’s “Nickname” is not set in the Controller.
- All call-to parties’ “Nickname” start the same letter.

A screenshot of the Phone Book showing the '#' tab selected. The list contains 'Sales group1', 'Planning group', and 'Accounts group'.

2. Transmitting a call

While holding down [PTT], speak into the microphone at your normal voice level.

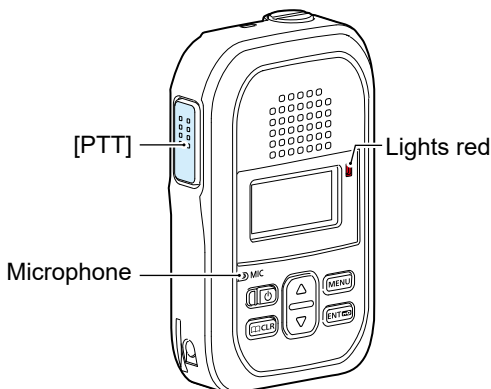

- The status indicator lights red.



Using a Call history entry

The Call history item may be usable, depending on the Controller setting.

1. Selecting a call-to party from the Call history

1. Push [MENU].
2. Push [▲]/[▼] to select “TX Log” or “RX Log,” and then push [ENT ].
(Example: TX Log)
3. Push [▲]/[▼] to select a call history type, and then push [ENT ].
(Example: TX Log)
4. Push [▲]/[▼] to select a call-to party, and then push [ENT ].
(Example: Sales group1)

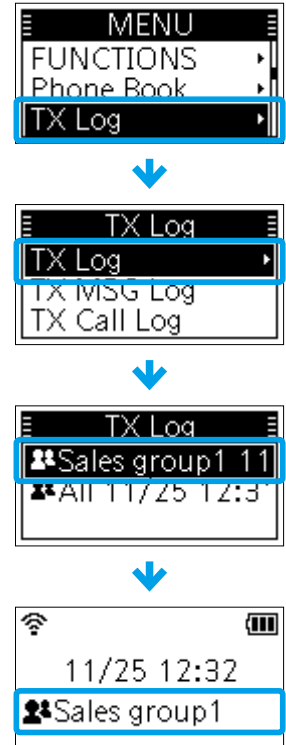
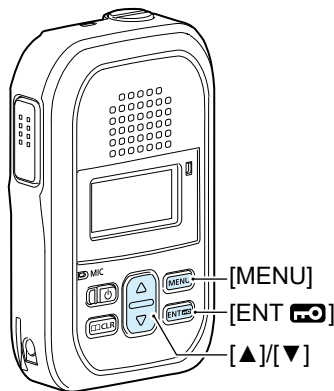

About the Call history log:

Up to 10 log entries can be saved. The oldest entry is automatically deleted when you receive the 11th call.

2. Transmitting a call

While holding down [PTT], speak into the microphone at your normal voice level.

- The status indicator lights red.

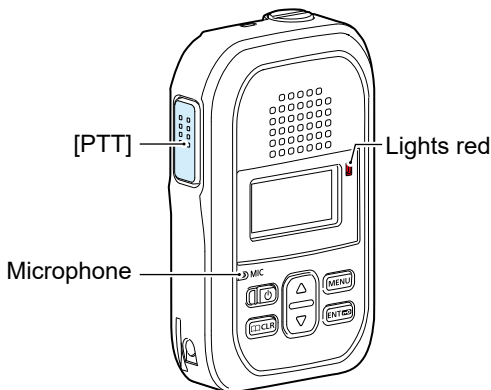

Using a Call history entry

Deleting history log entries:

1. Turn OFF the transceiver.
 2. While holding down [ENT], turn ON the transceiver.
 3. Release [ENT] when the Standby screen is displayed.
 4. Push [MENU].
 5. Push [▲]/[▼] to select “Settings,” and then push [ENT].
 6. Push [▲]/[▼] to select “Delete Log,” and then push [ENT].
 7. Push [▲]/[▼] to select “OK,” and then push [ENT].
 - All the entries except the recorded audio are deleted.
- ① See page 3-16 for deleting the recorded audio.

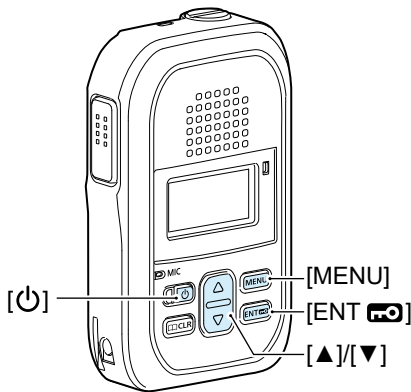

Section 3

ADVANCED OPERATION

Sending a message.....	3-2
Viewing received messages.....	3-3
Sending a Presence (Status) Call	3-4
Area Call function	3-5
Talkgroup Call function	3-6
◇ Multiplex Talkgroup.....	3-7
◇ Selecting a Talkgroup number from the MENU screen	3-8
◇ Selecting a Talkgroup number from the Phone Book.....	3-8
About the Programmable keys	3-9
Pocket Beep function.....	3-10
P-Bell function	3-10
VOX function	3-10
Emergency Call function.....	3-11
◇ Stationary Detection function	3-12
◇ Motion Detection function.....	3-12
◇ Lone Worker function	3-13
◇ Man Down function.....	3-14
Recording	3-15

Sending a message

This function may be usable, depending on the Controller setting.

1. Selecting a call-to party

1. Push [CLR].
 - ① You can also open the Phone Book in the MENU screen. (p. 4-3)
2. Push [▲]/[▼] to select a call type, and then push [ENT].
(Example: Group)
 - ① See page 3-6 about Talkgroup.
3. Push [▲]/[▼] to select a tab, and then push [ENT]. (Example: S)
4. Push [▲]/[▼] to select a call-to party, and then push [ENT].
(Example: Sales group1)

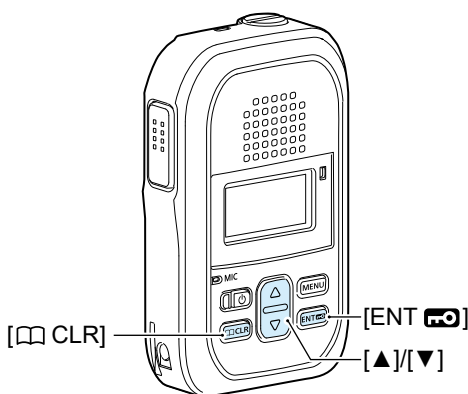

① You can also select the call-to party from the Call history entries. (p. 2-5)

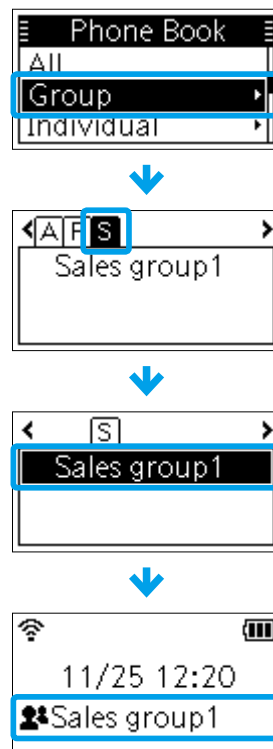

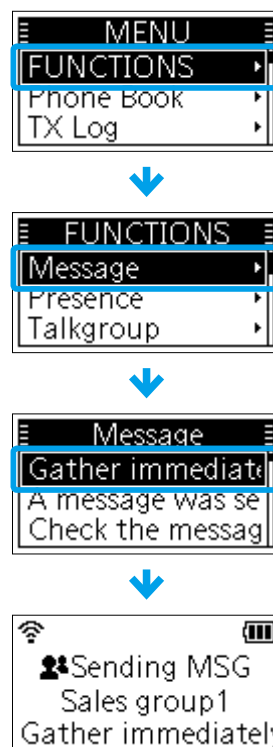
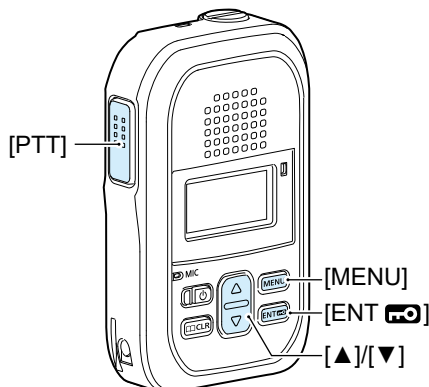

2. Selecting a message

1. Push [MENU].
2. Push [▲]/[▼] to select "FUNCTIONS," and then push [ENT].
3. Push [▲]/[▼] to select "Message," and then push [ENT].
4. Push [▲]/[▼] to select a message.
 - The selected message may scroll, depending on the message length.
5. Push [PTT] or [ENT].
 - The selected message is transmitted.



Viewing received messages

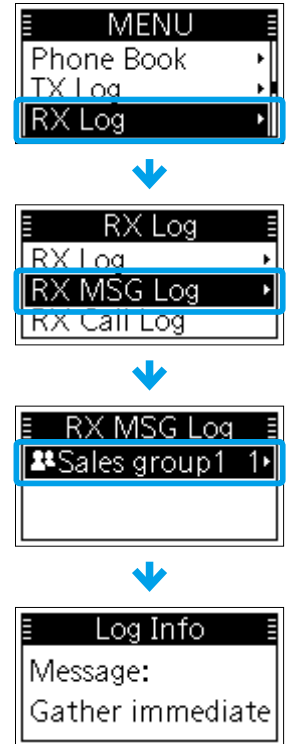
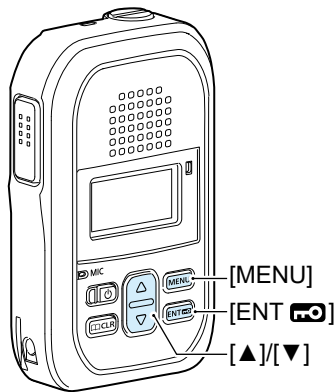

This function may be usable, depending on the Controller setting.

1. Push [MENU].
2. Push [▲]/[▼] to select "RX Log," and then push [ENT ].
3. Push [▲]/[▼] to select "RX MSG Log," and then push [ENT ].
 - The sender, and the received date and time are displayed on the "RX MSG Log" screen.
4. Push [▲]/[▼] to select a message to display, and then push [ENT ].
 - The selected message may scroll, depending on the message length.



Sending a Presence (Status) Call

This function may be usable, depending on the Controller setting.

1. Push [MENU].
2. Push [▲]/[▼] to select "FUNCTIONS," and then push [ENT ].
3. Push [▲]/[▼] to select "Presence," and then push [ENT ].
4. Push [▲]/[▼] to select your status.
5. Push [PTT] or [ENT ].
 - The selected status is transmitted.



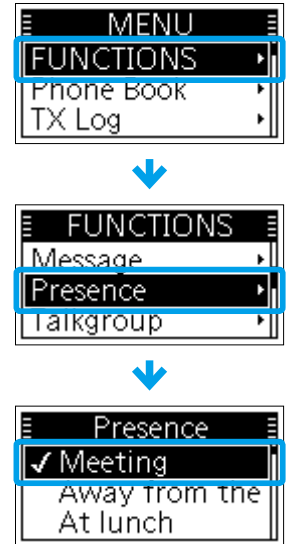
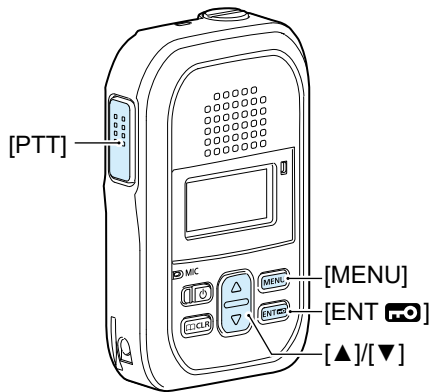

NOTE: A transmitted status can only be confirmed with your system Controller or the IP100FS REMOTE COMMUNICATOR. The transmitted status is not displayed on the IP110H.



Area Call function



The Area Call function enables you to call the areas that the selected wireless Access Points cover. The Area Call function may be usable, and the areas you can call may differ, depending on the Controller setting.

1. Turning ON the Area Call function

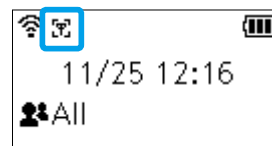
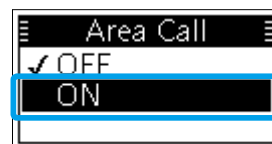
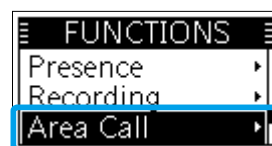
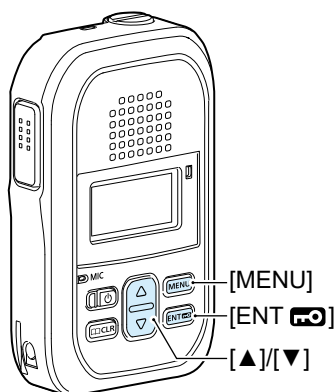
1. Push [MENU].
2. Push [▲]/[▼] to select “FUNCTIONS,” and then push [ENT ].
3. Push [▲]/[▼] to select “Area Call,” and then push [ENT ].
4. Push [▲]/[▼] to select “ON,” and then push [ENT ].
5. Push [MENU].
 - Exits the MENU screen.
 - “” is displayed on the Standby screen.



2. Selecting a call-to party and transmitting a call

1. Push [CLR].
 - ① You can also open the Phone Book in the MENU screen. (p. 4-3)
2. Push [▲]/[▼] to select a call type, and then push [ENT ].
(Example: Group)
- ① See page 3-6 about Talkgroup.
3. Push [▲]/[▼] to select a tab, and then push [ENT ]. (Example: S)
4. Push [▲]/[▼] to select a call-to party, and then push [ENT ].
(Example: Sales group1)
5. While holding down [PTT], speak into the microphone at your normal voice level.

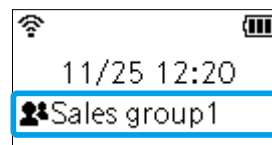
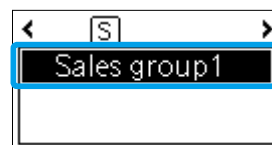
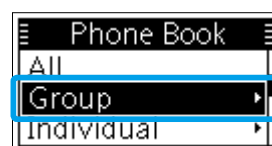
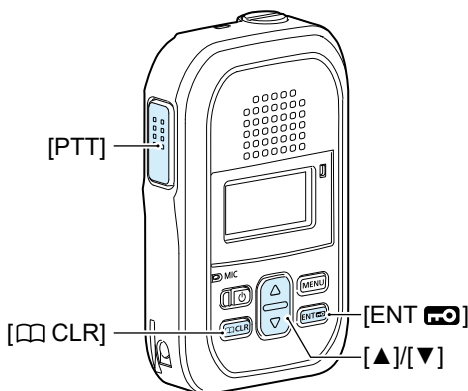

① You can also select the call-to party from the Call History entries. (p. 2-5)

Talkgroup Call function

The Talkgroup Call function enables you to communicate with call-to parties in the same Talkgroup. For example, in the illustration below, when IP110H “00004” in its normal group of “10001” selects Talkgroup “20001,” it is excluded from group “10001,” and can communicate with only IP110Hs “00006” and “00008” that belong to Talkgroup “20001.”

- ① This function may be usable only when the Talkgroup number is registered, and the Talkgroup Call function is assigned to a key in the Controller.
- ② Ask your system manager about whether or not to include the Talkgroup in All Call.

When Talkgroup is OFF

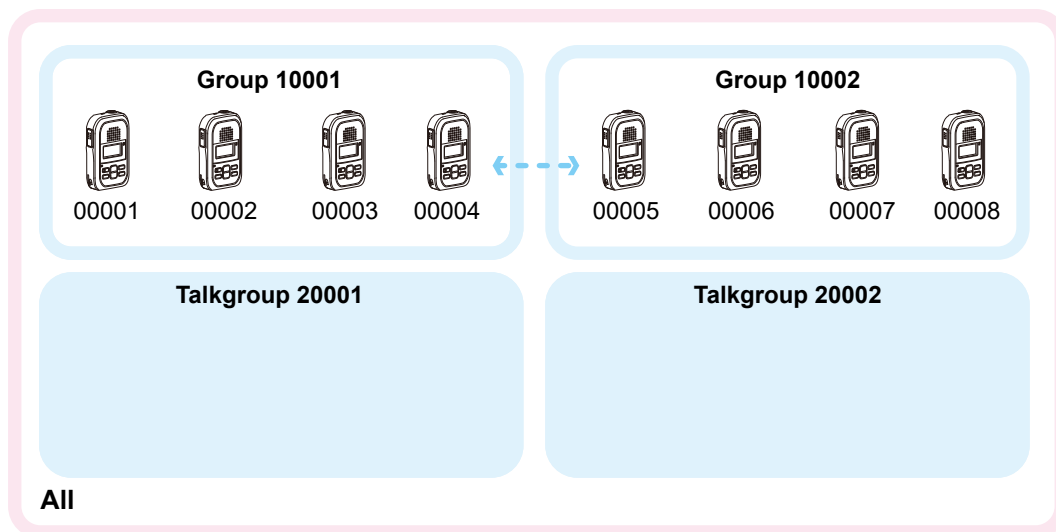

When Talkgroup is selected

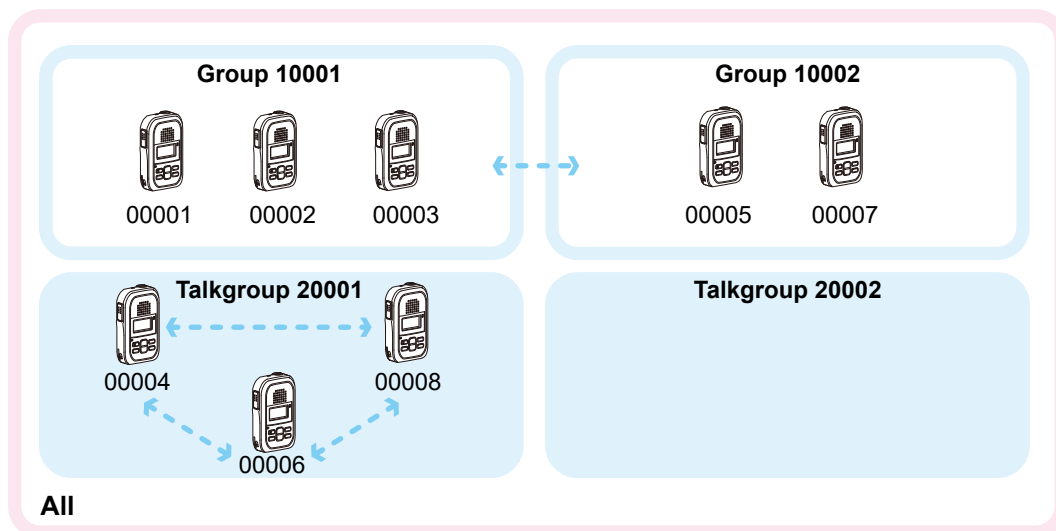

Talkgroup Call function

◇ Multiplex Talkgroup

This function may be usable only when Talkgroup is set as Multiplex Talkgroup in the Controller. When you select Multiplex Talkgroup, you can make a Talkgroup call between the linked Talkgroups.

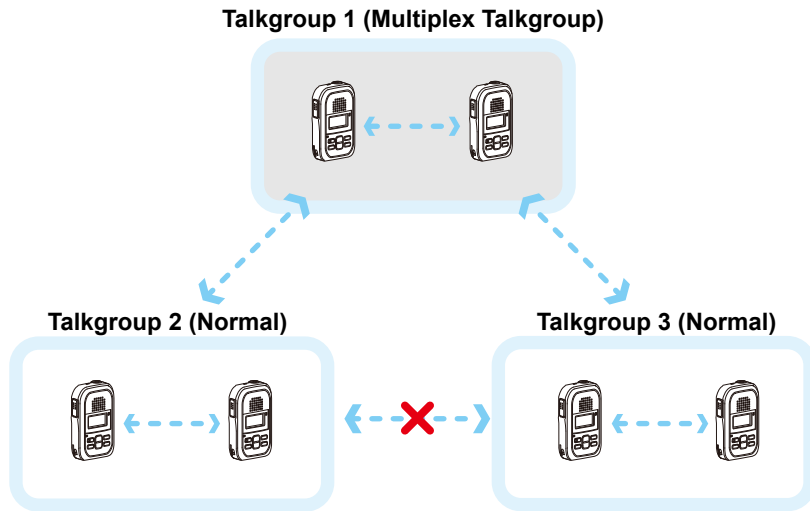

Example: When 2 normal Talkgroups (Talkgroup 2 and 3) belong to a Multiplex Talkgroup (Talkgroup 1)

- Talkgroup 1 can call Talkgroup 1, Talkgroup 2, and Talkgroup 3.
- Talkgroup 2 can call Talkgroup 1 and Talkgroup 2.
- Talkgroup 3 can call Talkgroup 1 and Talkgroup 3.

Talkgroup Call function

◇ Selecting a Talkgroup number from the MENU screen

This function may be usable only when the Talkgroup selection is assigned to the [MENU] key in the Controller.

1. Push [MENU].
 2. Push [▲]/[▼] to select "FUNCTIONS," and then push [ENT].
 3. Push [▲]/[▼] to select "Talkgroup," and then push [ENT].
 4. Push [▲]/[▼] to select a Talkgroup you want to belong to, and then push [ENT]. (Example: Talkgroup1)
 5. Push [MENU].
 - Exits the MENU screen.
 - The transceiver is ready to talk to only the transceivers that belong to the same Talkgroup.
- ① While the Talkgroup number is selected, you cannot make Normal Group calls.
 ① You can leave Talkgroup and return to the Normal Group by selecting "OFF" in Step 4 on the "Talkgroup" screen.

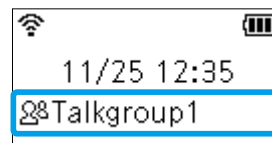
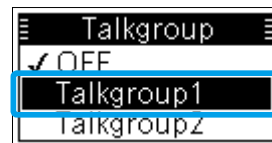
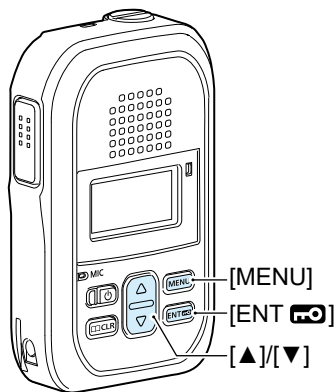

"Talkgroup1" is selected.

◇ Selecting a Talkgroup number from the Phone Book

This function may be usable only when the Talkgroup selection is assigned to the [CLR] key in the Controller.

1. Push [CLR].
 2. Push [▲]/[▼] to select "Talkgroup," and then push [ENT].
 3. Push [▲]/[▼] to select a Talkgroup that you want to belong to, and then push [ENT]. (Example: Talkgroup1)
 - The transceiver is ready to talk to only the transceivers that belong to the same Talkgroup.
- ① While the Talkgroup number is selected, you cannot make Normal Group calls.
 ① You can leave Talkgroup by selecting another call-to party from the Phone Book.

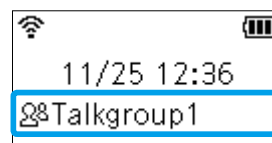
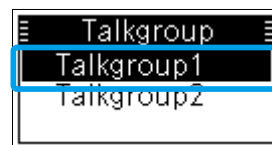
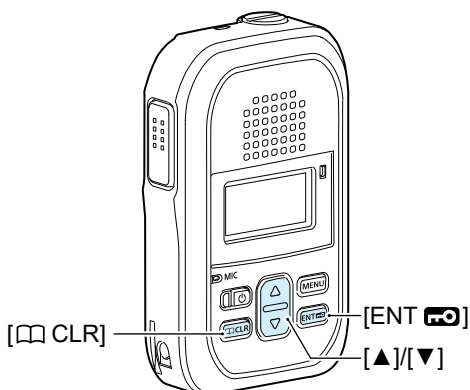

"Talkgroup1" is selected.

About the Programmable keys

One of the following functions may be assigned to the [CLR] or [MENU] key, depending on the Controller setting. Hold down the key for 1 second to use the assigned function.

Assignable functions:

Function	Icon	Action
Message		Selects an often-used message.
One Touch		Selects the often-used call type or call-to party. ① The displayed icon differs, depending on the call type.
Clear Down		Hangs up a Phone call. ① You can cancel the call by holding down the key for 1 second, before the target telephone is picked up, or during a Phone call. ① The transceiver can terminate a Phone call only when: <ul style="list-style-type: none"> • The transceiver is individually called from a telephone. • The transceiver calls a telephone.
Mute		Mutes or unmutes the received audio. <ul style="list-style-type: none"> • While muting, “” is displayed. ① The notification tone is not muted. ① Pushing [PTT] also releases the mute.
Emergency		Transmits an Emergency call. <ul style="list-style-type: none"> • Hold down the key until “Emergency” is displayed. ① The Emergency call is canceled when: <ul style="list-style-type: none"> • A call is received. • You hold down the same key until “Emergency” disappears. • The transceiver is turned OFF. • The time set in the Controller has passed.
Playback Recording		Plays back the latest recorded audio.
Temporary Audio Level		While receiving, you can change the audio level to the level set in the Controller by holding down the key.

- To confirm the assigned function, push [ENT] on the Standby screen.

Example: “Message” is assigned to [CLR], and “Mute” is assigned to [MENU].

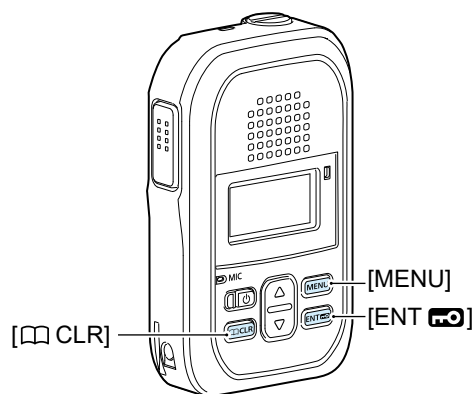
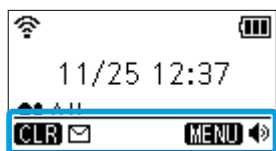

Pocket Beep function

The Pocket Beep function sounds a notification tone and displays “🔔” when a call is received.

- ① This function may be usable, depending on the Controller setting.
- ① When the Pocket Beep function is ON, “🔔” is displayed.
- ① When an Individual call is received, the notification beep sounds and “🔔” blinks.

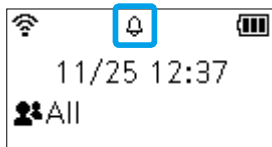

Standby screen



When an Individual call is received.

VOX function

The VOX function automatically switches between receive and transmit during voice operation. When the VOX function is ON, speak into the microphone to transmit, then stop speaking to receive. In the Full Duplex mode, you can speak and listen to the call-to party at the same time.

- ① This function may be usable, depending on the Controller setting.
- ① When the VOX function is ON, “VOX” is displayed.

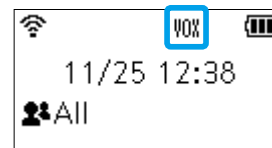

Standby screen

P-Bell function

The P-Bell function sounds the notification tone when a call is received.

- ① This function may be usable, depending on the Controller setting.
- ① When the P-Bell function is turned ON, “P” is displayed.
- ① You cannot listen to the call until you reply to it. After pushing [PTT], the mute is released.

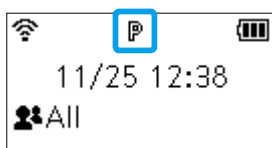

Standby screen

Emergency Call function

You can transmit or receive an Emergency call if the function is turned ON. The Emergency Call function may be assigned to the [MENU] or [CLR] key, depending on the Controller setting. (p. 3-9)

Transmitting an Emergency call

1. Hold down the key that the Emergency Call function is assigned to until "Emergency" is displayed.
 - An alarm periodically sounds.
 - ① When the Silent mode is set to "ON" in the Controller, no alarm sounds, and no emergency indication is displayed.
2. Wait for an answer back.
 - When the transceiver receives an answer back, the alarm stops, and the status indicator lights green.
 - ① To cancel the Emergency call, hold down the same key until "Emergency" disappears, or turn OFF the transceiver, depending on the Controller setting.



While making the Emergency call

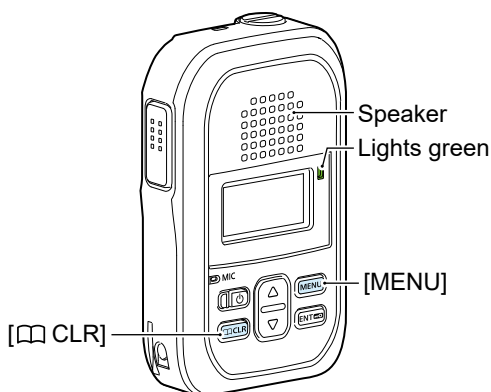

Receiving an Emergency call

1. "Emergency" is displayed, and the alarm periodically sounds.
 - The status indicator blinks red.
 - ① When the Silent mode is set to "ON" by the Controller, no alarm sounds.
2. While holding down [PTT], speak into the microphone at your normal voice level.
 - The status indicator lights red.
 - The alarm stops.
 - Returns to the normal mode when [PTT] is released.

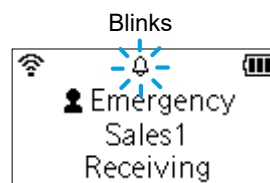

When an Emergency call is received.



While transmitting

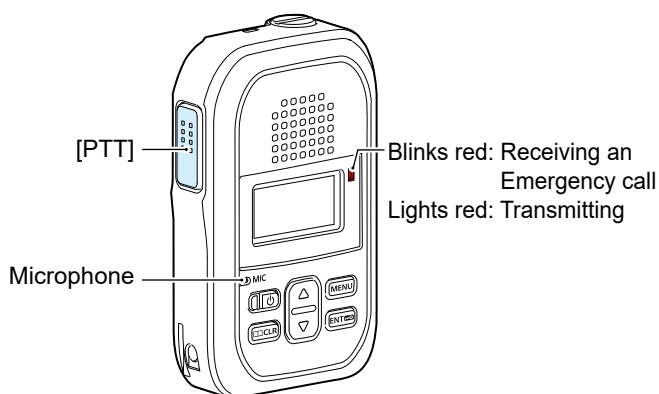

NOTE: The Emergency function may not properly work, depending on the surrounding environment such as the battery capacity, the signal strength, or the access point or network status. Icom is not responsible for the destruction or damage caused by using the Emergency Call function.

Emergency Call function

The transceiver may enter the Emergency mode through the following functions, depending on the Controller setting.

◇ Stationary Detection function

When the transceiver is detected as being stationary (no motion) for the ON Timer preset time, the transceiver enters the Emergency mode.

- ① If you move the transceiver during the Reminder Timer set time, the Emergency mode is canceled.

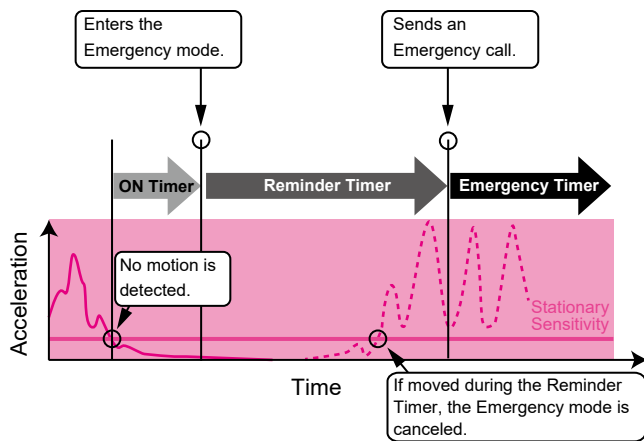

NOTE: The Stationary Detection function may not properly work, depending on the surrounding environment such as the battery capacity, the signal strength, or the access point or network status. Icom is not responsible for the destruction or damage caused by using the Stationary Detection function.

◇ Motion Detection function

When the transceiver continuously moves for the ON Timer preset time, the transceiver enters the Emergency mode.

- ① If the transceiver stops moving during the Reminder Timer set time, the Emergency mode is canceled.

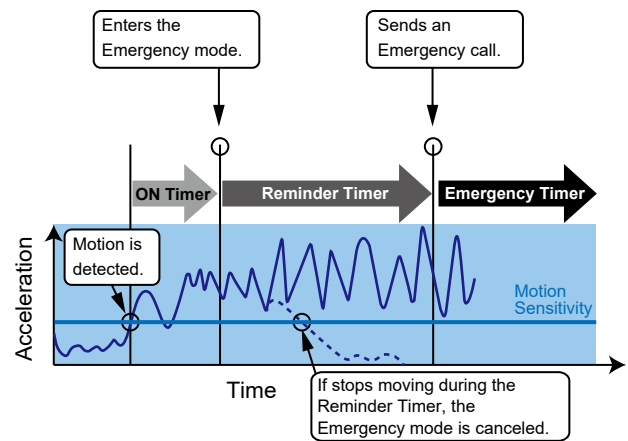

NOTE: The Motion Detection function may not properly work, depending on the surrounding environment such as the battery capacity, the signal strength, or the access point or network status. Icom is not responsible for the destruction or damage caused by using the Motion Detection function.

Emergency Call function

The transceiver may enter the Emergency mode through the following functions, depending on the Controller setting.

◇ Lone Worker function

When no operation occurs for the ON Timer preset time, the transceiver enters the Emergency mode.

- ① If you push any key before the Reminder Timer preset time expires, the Emergency mode is canceled.

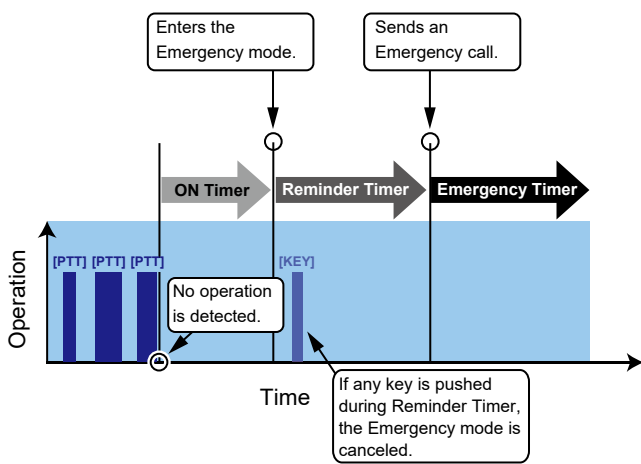

Lone Worker with Stationary

The transceiver enters the Emergency mode when:

- No operation occurs for the ON Timer preset time. AND
- The transceiver is detected as stationary (no motion) for the ON Timer preset time.

- ① If you push any key, or move the transceiver before the Reminder Timer preset time expires, the Emergency mode is canceled.

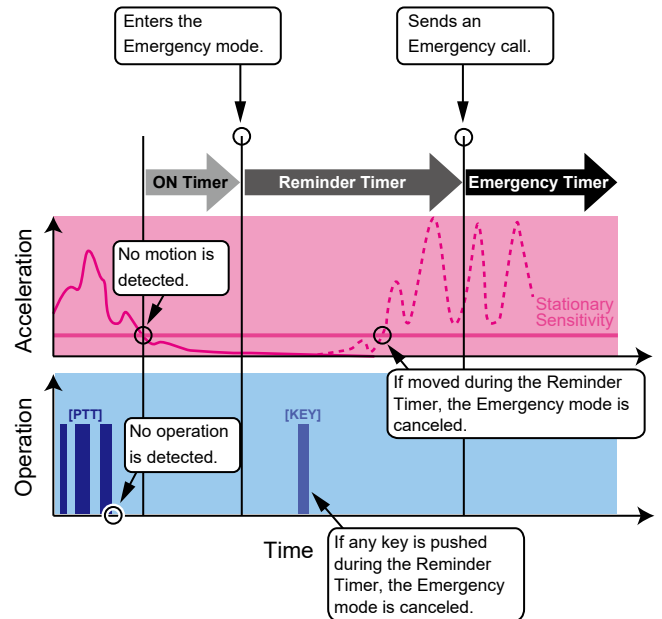

NOTE: The Lone Worker may not properly work, depending on the surrounding environment such as the battery capacity, the signal strength, or the access point or network status. Icom is not responsible for the destruction or damage caused by using the Lone Worker function.

Emergency Call function

The transceiver may enter the Emergency mode through the following functions, depending on the Controller setting.

◇ Man Down function

When the transceiver is tilted past the preset angle for the ON Timer preset time, the transceiver enters the Emergency mode.

- ① If you raise the transceiver back from the preset angle towards the vertical position before the Reminder Timer expires, the Emergency mode is canceled.

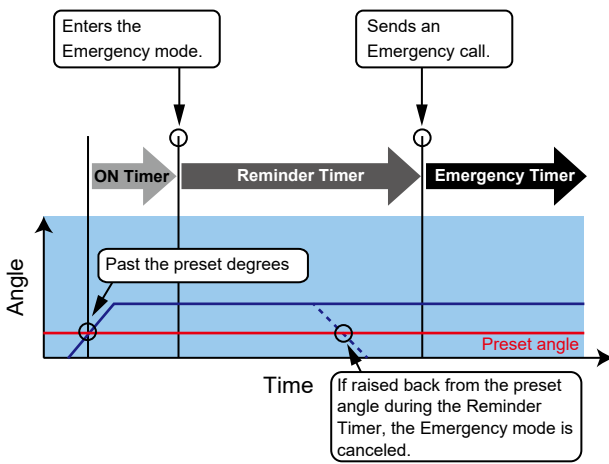

Man Down with Stationary

The transceiver enters the Emergency mode when:

- The transceiver leans past the preset angle for the ON Timer preset time.
- AND
- The transceiver is detected as stationary (no motion) for the ON Timer preset time.

- ① If you raise the transceiver back from the preset angle towards the vertical position, or move the transceiver before the Reminder Timer preset time expires, the Emergency mode is canceled.

Example

Preset angle: 45 degrees

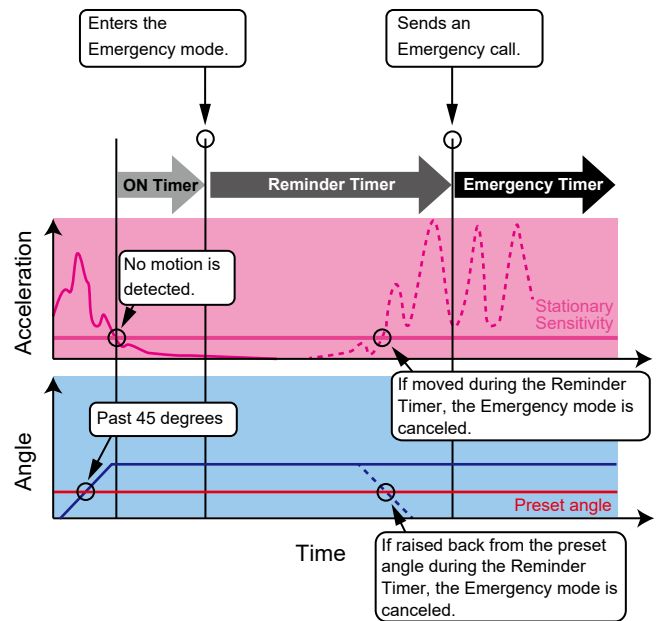







NOTE: The Man Down function may not properly work, depending on the surrounding environment such as the battery capacity, the signal strength, or the access point or network status. Icom is not responsible for the destruction or damage caused by using the Man Down function.

Recording

The Recording function records the audio until a call is finished. The recording duration of a single file is up to 4 minutes. The oldest file will be automatically deleted when the 11th call is recorded, or the recording time exceeds 4 minutes.

- ① This function may be usable, depending on the Controller setting.
- ① Only Individual calls may be recorded, depending on the Controller setting.
- ① In the Full Duplex mode, only the call-to party's voice is recorded.
- ① You cannot export the recorded audio.

Turning ON the Recording function

1. Push [MENU].
2. Push [▲]/[▼] to select "FUNCTIONS," and then push [ENT ].
3. Push [▲]/[▼] to select "Recording," and then push [ENT ].
4. Push [▲]/[▼] to select "ON," and then push [ENT ].
5. Push [MENU].
 - Exits the MENU screen.
 - When the Recording function is ON, "" is displayed.
 - ① "" blinks while recording.
 - ① "" blinks when there is recorded audio that has not been played yet.

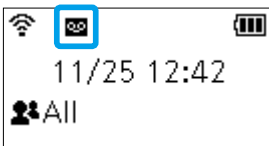
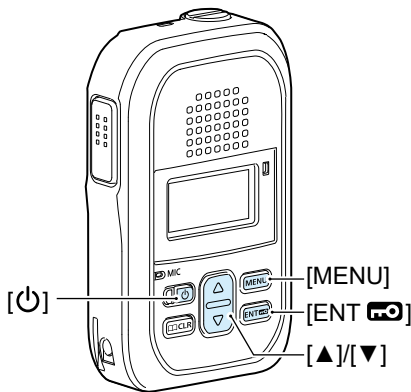
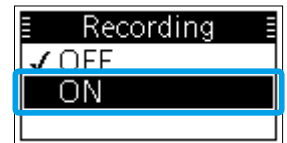
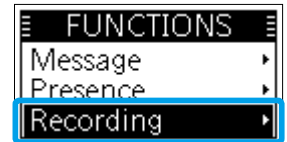

The Recording function is ON.



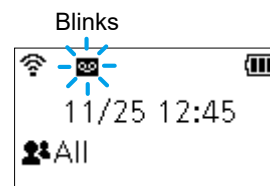

While recording



When there is new recorded audio.



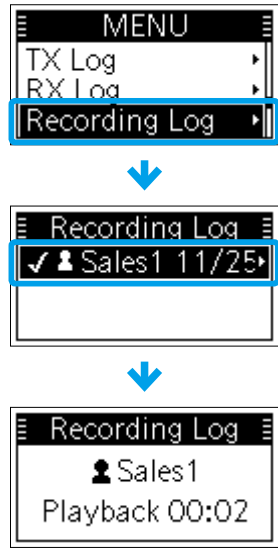
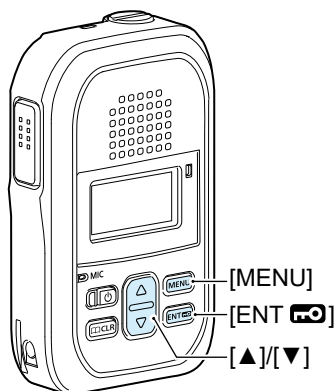

Recording

Playing the recorded audio

1. Push [MENU].
2. Push [▲]/[▼] to select “Recording Log,” and then push [ENT ].
 Ⓜ The “Recording Log” screen is not displayed if no recorded audio is saved.
3. Push [▲]/[▼] to select the recorded audio to play.
 Ⓜ “✓” is displayed if recorded audio has not been played yet.
4. Push [ENT ] to play the selected audio.
 Ⓜ Push [ENT ] to stop playing.



Deleting all the recorded audio history

1. Turn OFF the transceiver.
2. While holding down [ENT ], turn ON the transceiver.
3. Release [ENT ] when the Standby screen is displayed.
4. Push [MENU].
5. Push [▲]/[▼] to select “Settings,” and then push [ENT ].
6. Push [▲]/[▼] to select “Delete Recording,” and then push [ENT ].
7. Push [▲]/[▼] to select “OK,” and then push [ENT ].
 • All the recorded audio data is deleted.

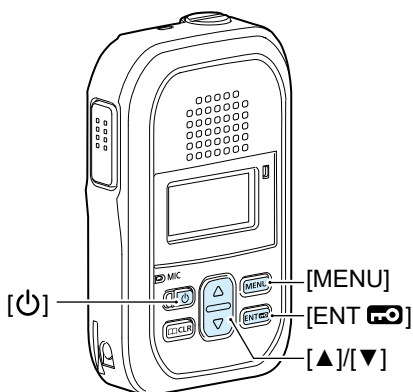

Section 4 MENU SCREEN

Using the MENU screen	4-2
MENU screen items.....	4-3

Using the MENU screen



There are 2 types of MENU screens, Basic and Advanced.

① See pages 4-3 and 4-4 for details of each screen item.

To display the Basic MENU screen:

Push [MENU] when the Standby screen is displayed.

To display the Advanced MENU screen:

1. Turn OFF the transceiver.
2. While holding down [ENT , turn ON the transceiver.
3. Release [ENT ] when the Standby screen is displayed.
4. Push [MENU].

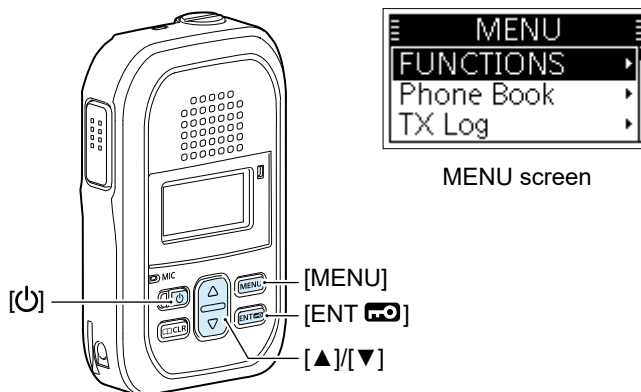

To select a MENU item:

Push [▲]/[▼] to select an item, and then push [ENT ].

MENU screen items

The shaded items (■) are also displayed on the Basic MENU screen.

① Items or default values may differ, depending on the Controller setting.

Item	Description	Option/range
FUNCTIONS		
Message	Selects a message to transmit.	Depends on the Controller setting.
Presence	Selects a status to transmit.	Depends on the Controller setting.
Talkgroup	Sets the call type to Talkgroup call, and selects a Talkgroup number that you want to belong to.	Depends on the Controller setting.
Recording	Selects whether or not to enable the Recording function.	OFF or ON
Area Call	Selects whether or not to enable the Area Call function. (p. 3-5)	OFF or ON
One Touch PTT	Selects whether or not to enable the One Touch PTT function. The function toggles receiving and transmitting by momentarily pushing [PTT]. ① Push [PTT] to talk, and push again to return to receive. ① When "ON" is selected, you do not have to hold down [PTT] while you are talking.	OFF or ON
Phone Book		
All	Sets the call type to All call.	—
Group	Sets the call type to Group call, and selects a call-to party.	Depends on the Controller setting.
Talkgroup	Sets the call type to Talkgroup call, and selects a Talkgroup number that you want to belong to.	Depends on the Controller setting.
Individual	Sets the call type to Individual call, and selects a call-to party.	Depends on the Controller setting.
Telephone	Sets the call type to Phone call, and selects a call-to party.	Depends on the Controller setting.
TX Log		
TX Log	Displays the TX Call History.	Up to 10 log entries
TX MSG Log	Displays the TX Message History.	Up to 10 log entries
TX Call Log	Displays the TX Phone Call History.	Up to 10 log entries
RX Log		
RX Log	Displays the RX Call History.	Up to 10 log entries
RX MSG Log	Displays the RX Message History.	Up to 10 log entries
RX Call Log	Displays the RX Phone Call History.	Up to 10 log entries
Recording Log	Displays the recorded audio list.	Up to 10 audio files

4 MENU SCREEN

MENU screen items

The shaded items (■) are also displayed on the Basic MENU screen.

① Items or default values may differ, depending on the Controller setting. Ask your dealer for details.

Item	Description	Option/range
Settings		
Bluetooth		
Functions	Selects whether or not to enable the Bluetooth function.	OFF or ON
Auto Connect	Selects whether or not to automatically connect a Bluetooth device.	OFF or ON
Search Device	Searches for Bluetooth devices.	—
Pairing List	Displays the paired Bluetooth devices in the list.	—
BT AF Output	Selects the AF Output device when a Bluetooth headset is connected.	Headset Only or Headset & SP
One Touch PTT	Selects whether or not to enable the One Touch PTT function when using a Bluetooth device. The function toggles receiving and transmitting by momentarily pushing [PTT]. ① Push [PTT] to talk, and push again to return to receive. ① When "ON" is selected, you do not have to hold down [PTT] while you are talking. ① Icom has checked the PTT operation with some 3M Peltor headsets, such as the WS Headset XP, WS ProTac XP and WS Alert XP, however, compatibility is not guaranteed.	OFF or ON
Mic Line Switch	Select which microphone to use while the Bluetooth headset is connected. • Auto: Transmits the audio from the device whose [PTT] is pushed. • Radio Mic: When pushing the Bluetooth headset's [PTT], the IP110H transmits the audio from the optional microphone, if connected, or the transceiver's microphone if no optional microphone is connected. ① No audio may be transmitted, depending on the type of connected microphone and the transceiver settings. ① When pushing [PTT] on other than the Bluetooth headset, transmits the audio from the device whose [PTT] is pushed. • Bluetooth Mic: Transmits the audio from the Bluetooth headset's microphone, no matter which [PTT] is pushed.	Auto, Radio Mic, or Bluetooth Mic
Initialize	Initializes the built-in Bluetooth unit and pairing list.	OK or Cancel
Delete log	Deletes the call histories.	OK or Cancel
Delete Recording	Deletes the recorded audio.	OK or Cancel
Contrast	Sets the screen contrast.	1 ~ 16
Clock	Selects the format to display the time.	24 hours or 12 hours
Mic Gain	Sets the microphone sensitivity. ① Higher values make the microphone more sensitive to your voice.	-12 dB ~ 12 dB (in 3 dB steps)
Care Charge	Selects whether or not to use the Care Charge function. When the Care Charge function is ON: • Starts charging if the battery capacity is less than 60%. • Stops charging if the battery capacity is more than 70%.	OFF or ON
Authentication	Displays the authentication acquired with the transceiver.	—

Section 5 OPTIONS

Options	5-2
Battery life and charging time	5-3
Charging with the BC-257	5-4
Using a Bluetooth headset	5-5
◇ About the VS-3 Bluetooth headset	5-5
◇ Pairing the IP110H with the VS-3	5-6
◇ Disconnecting a Bluetooth device from the IP110H	5-8
◇ Deleting a Bluetooth device from the pairing list	5-9
◇ Initializing the pairing list of the transceiver	5-10

Options

Chargers

- **BC-257** BATTERY CHARGER
- **BC-228** AC ADAPTER
When using multiple BC-257s connected together.

Belt clip

- **MBB-1** BELT CLIP

Cables

- **OPC-2132** PLUG ADAPTER CABLE
For 2 pin (3.5 mm (1/8 inch), 2.5 mm) connector
- **OPC-2133** PLUG ADAPTER CABLE
For 1 pin (2.5 mm) connector
- **OPC-1655** PROGRAMMING ADAPTER CABLE
- **OPC-478UC***1 PROGRAMMING CABLE
- **OPC-478UC-1***1 PROGRAMMING CABLE

*1 The OPC-1655 (Programming adapter cable) is required.

Speaker-Microphones

- **HM-186PI** COMPACT SPEAKER MICROPHONE
- **HM-228** SPEAKER MICROPHONE
Full sized waterproof speaker microphone including an alligator type clip to attach to your shirt or collar, and so on.

Headsets and Earphone microphone

- **HS-94***2*3 HEADSET (Ear hook type)
- **HS-95***2*3 HEADSET (Neck and arm type)
- **HS-97***2*3 HEADSET (Throat Microphone)
- **VS-3***3 Bluetooth® HEADSET
- **HM-179PI** DURABLE EARPHONE MICROPHONE

*2 The OPC-2133 (Plug adapter cable) is required.

*3 The VOX function may be usable, depending on the Controller setting.

Earphone

- **SP-16PIBW** EARPHONE (Ear hook type)

About the free download software

You can download the CS-IP110H PROGRAMMING SOFTWARE from the Icom website.

Before using, read the manual, and use it according to the instructions.

① To add or expand a function, or to improve the performance, the software version may be upgraded.

Before you update your software version, see the instructions and cautions described on the Icom website.

Battery life and charging time

Battery life

Approximately 26.5 hours

TX : RX : Stand-by = 1 : 1 : 8

NOTE: Operating time may be shorter, if the transceiver is out of a service area for a long time, or continuously searching for an Access Point (roaming).

Charging time

Supplied USB cable	Approximately 4 hours*
A single BC-257 with the supplied USB cable	Approximately 4.5 hours*
Multiple BC-257s connected together	Approximately 4 hours

* When using the supplied USB cable with a 5 V/2 A output AC adapter.

CAUTION: Read the 'Battery caution' and 'Charging caution' on INSTRUCTIONS (supplied with the transceiver) before charging.

Charging with the BC-257

To charge with the BC-257, use the supplied USB cable and user supplied AC adapter.

① You can connect up to 4 BC-257s together by using the BC-228 optional AC adapter.

CAUTION: DO NOT connect anything to the [USB] port on the transceiver when placing the transceiver in the BC-257. This may cause the charger's malfunction.

NOTE:

- After charging is completed, the charger will automatically recharge the battery when the battery voltage decreases.
- Disconnect the AC adapter from the outlet when the charger is not in use.
- Use a 5 V/2 A output AC adapter.
- The charging time may differ, depending on the AC adapter. When you use a low output AC adapter, it may take longer to charge, or the transceiver may not be charged.
- Before using the AC adapter, thoroughly read its instructions.

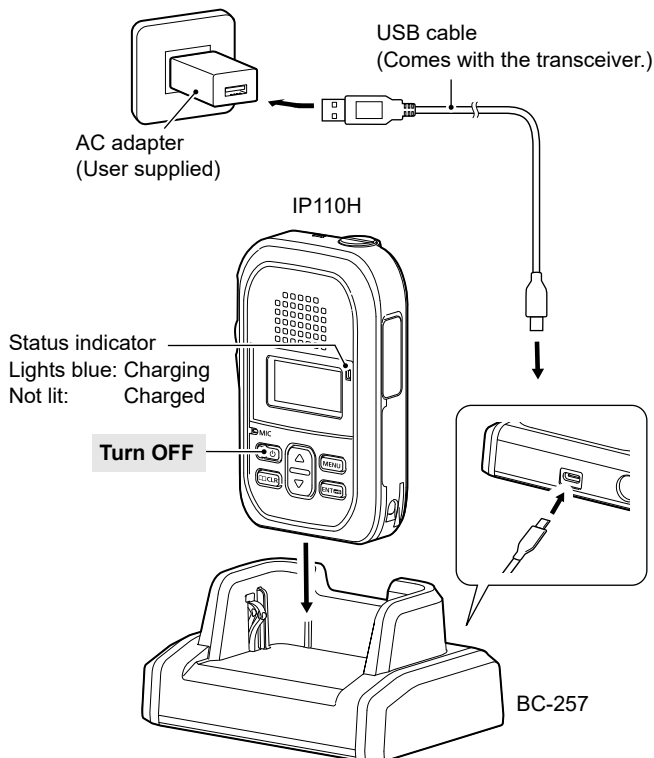

Connecting BC-257s together

1. Remove the charger's right cover. (①)
2. Snap the DC power plug to another charger's DC power jack. (②)

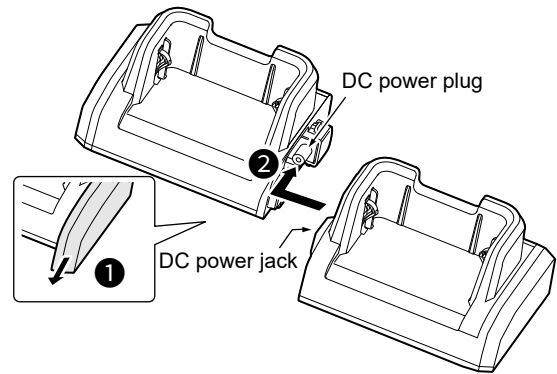

⚠ WARNING! NEVER connect more than 4 chargers together. It may result in an electric shock, cause a fire, overheating, or damage the chargers.

⚠ WARNING! NEVER use other than the BC-228 AC adapter when connecting multiple BC-257 units. It may result in an electric shock, cause a fire, overheating, or damage the chargers.

3. Follow procedures ① to ④ to charge with multiple BC-257s.

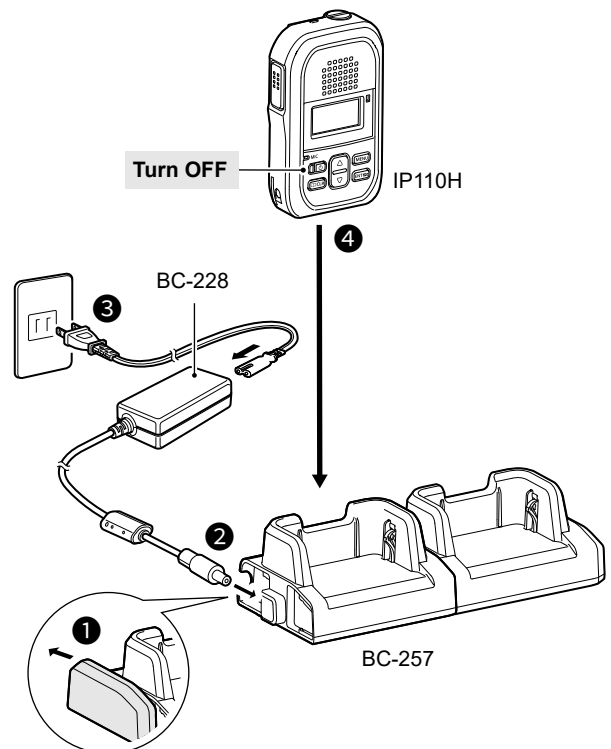

Using a Bluetooth headset

You can connect to other Bluetooth headsets with the built-in Bluetooth unit.

- ① Only the VS-3 is guaranteed as of September 2022.
- ① This function may be usable, depending on the transceiver setting. (p. 5-5)

- The communication range of Bluetooth is approximately 10 meters (33 feet).
- Although you can enter up to 4 Bluetooth devices in the transceiver device list, it is recommended that you pair only one device at a time.

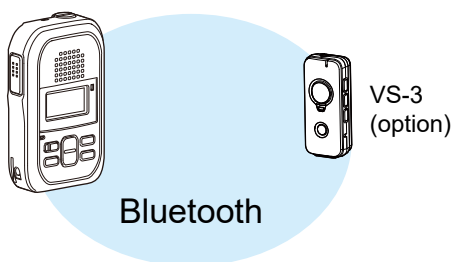

Electromagnetic Interference

When you use a Bluetooth device, pay attention to the following:

Bluetooth devices operate in the 2.4 GHz band that is also used by other appliances, such as Wireless LAN products, microwave ovens, RFID systems, amateur radio stations, and so on.

When using a Bluetooth device near such devices, interference may occur, causing a decrease in communication speed, and an unstable connection. In such case, keep the Bluetooth devices away from the other appliances, or stop using those devices. Bringing the Bluetooth device and the transceiver closer together also improves communication.

◇ About the VS-3 Bluetooth headset

When you connect an optional VS-3 Bluetooth headset to the transceiver, you can wirelessly transmit and receive the headset audio.

The VS-3 has a [PTT] switch, so you can transmit in the same way as using the transceiver's [PTT] switch.

NOTE:

- If the headset does not work correctly, even if the headset is turned ON, push [RESET] with a pin to force power OFF.
- When the volume is set to too low, the audio may not be loud enough to hear. Setting the volume level to "28" or higher is recommended.

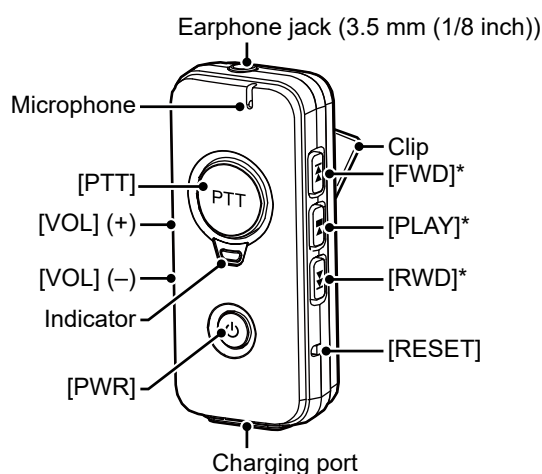

* One of the functions described on page 3-9 may be assigned to the key, depending on the Controller setting.

Function		Operation	Beep tone	Indicator
Power	ON	Hold down [PWR] for 3 seconds.	Melody (up)	Blinks blue
	OFF		Melody (down)	OFF
Pairing mode	Searching	While the VS-3 is OFF, hold down [PWR] for 6 seconds.	PiPa- (ready to connect)	Quickly blinks red then blue, every 3 seconds
	Connected		PiRo	Blinks blue twice, every 3 seconds
Transmit*1		Push [PTT]	Pi*2	Blinks red once, then blue twice, every 3 seconds
Audio volume	Up*1	Push [VOL] (+)	Pi	-
	Down*1	Push [VOL] (-)	Boo	-





*1 You can use only when a Bluetooth headset is connected to the transceiver.

*2 Depends on the Notice Tone settings or Bluetooth PTT Beep setting in the Controller.

Using a Bluetooth headset

◇ Pairing the IP110H with the VS-3

1. Turning ON the transceiver's Bluetooth function

1. Push [MENU].
2. Push [▲]/[▼] to select "Settings," and then push [ENT .
3. Push [▲]/[▼] to select "Bluetooth," and then push [ENT .
4. Push [▲]/[▼] to select "Functions," and then push [ENT .
5. Push [▲]/[▼] to select "ON," and then push [ENT .

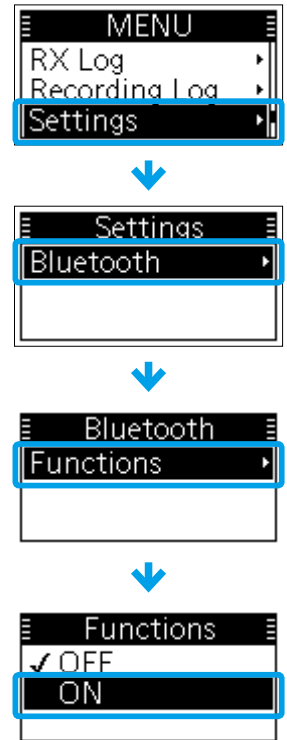
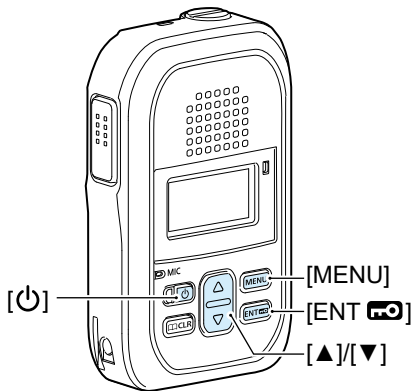

2. Entering the VS-3 Pairing mode

1. Confirm the VS-3 is turned OFF.
2. Hold down [PWR] for 6 seconds.
 - The indicator quickly blinks red then blue, and then the headset enters the Pairing mode.

NOTE:

- Charge the VS-3 before operating.
- The VS-3 automatically starts up in the Pairing mode after turning ON, if no Bluetooth device is entered in its Pairing list.

Using a Bluetooth headset

◇ Pairing the IP110H with the VS-3

3. Pairing and connecting the Bluetooth device

1. Push [MENU].
2. Push [▲]/[▼] to select “Settings,” and then push [ENT].
3. Push [▲]/[▼] to select “Bluetooth,” and then push [ENT].
4. Push [▲]/[▼] to select “Search Device,” and then push [ENT].
 - The transceiver searches for a Bluetooth device.
 - If found, the device’s name is displayed on the screen.
(Example: ICOM BT-002)
 - ① Push [CLR] to cancel searching.
 - ① If “Failed” is displayed, confirm that the headset is in the Pairing mode, and then retry searching.
5. Push [▲]/[▼] to select the headset to pair and connect, and then push [ENT].
6. Push [▲]/[▼] to select “Pairing,” and then push [ENT].
 - “Pairing Successful” is displayed when the pairing has been completed.
 - “✓” is displayed at the left of the connected device name.
7. Push [MENU].
 - Exits the MENU screen.
 - “” is displayed when the headset is connected to the transceiver.

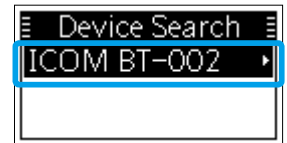
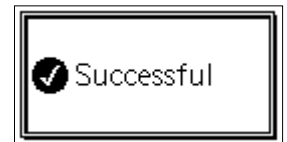
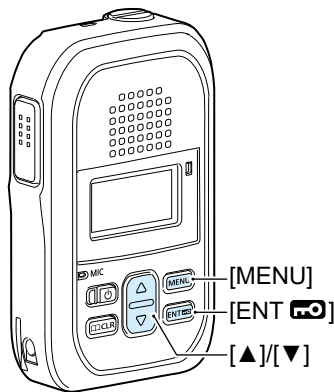

NOTE:

- You may not find a target Bluetooth device if there are many other Bluetooth devices nearby. In that case, stop using those devices, or move away from them.
- If the Bluetooth device is disconnected, the audio is output from the transceiver. Be sure not to set the transceiver’s volume level too high.







TIP: How to automatically connect to the paired device
 The transceiver automatically connects to the paired device when:

- The Bluetooth function is ON.
- No other Bluetooth device is connected to the transceiver.
- The paired device is ON.
- “Auto Connect” is set to “ON.” (p. 4-3)

① “” is displayed when the headset is connected to the transceiver.

Using a Bluetooth headset

◇ Disconnecting a Bluetooth device from the IP110H



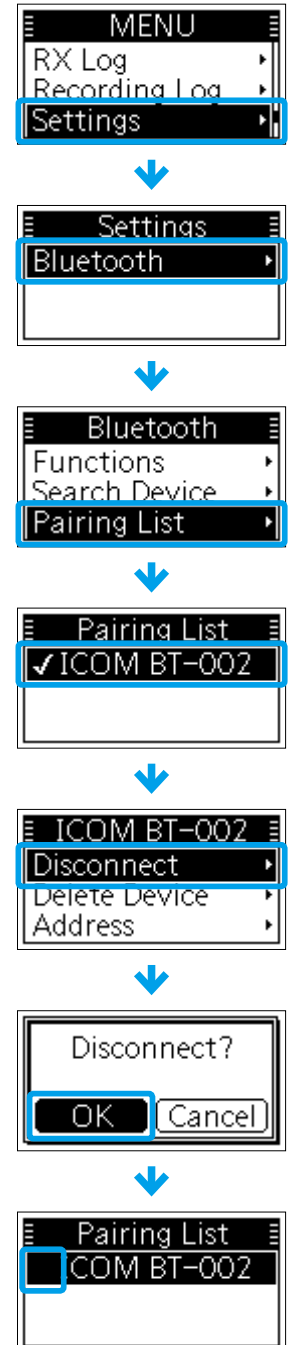
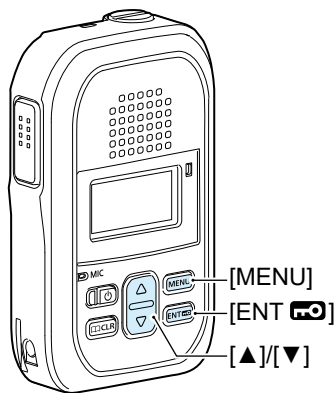



1. Push [MENU].
2. Push [▲]/[▼] to select “Settings,” and then push [ENT ].
3. Push [▲]/[▼] to select “Bluetooth,” and then push [ENT ].
4. Push [▲]/[▼] to select “Pairing List,” and then push [ENT ].
5. Push [▲]/[▼] to select the device to disconnect, and then push [ENT ].
6. Push [▲]/[▼] to select “Disconnect,” and then push [ENT ].
7. Push [▲]/[▼] to select “OK,” and then push [ENT ].
 - “✓” disappears if the headset is correctly disconnected.
8. Push [MENU].
 - Exits the MENU screen.



Using a Bluetooth headset

◇ **Deleting a Bluetooth device from the pairing list**

① Disconnect the Bluetooth device before deleting it, if connected. (p. 5-8)

1. Push [MENU].
2. Push [▲]/[▼] to select “Settings,” and then push [ENT .
3. Push [▲]/[▼] to select “Bluetooth,” and then push [ENT .
4. Push [▲]/[▼] to select “Pairing List,” and then push [ENT .
5. Push [▲]/[▼] to select the device to delete, and then push [ENT .
6. Push [▲]/[▼] to select “Delete Device,” and then push [ENT .
7. Push [▲]/[▼] to select “OK,” and then push [ENT ].
 - The selected device is deleted from the pairing list.
8. Push [MENU].
 - Exits the MENU screen.

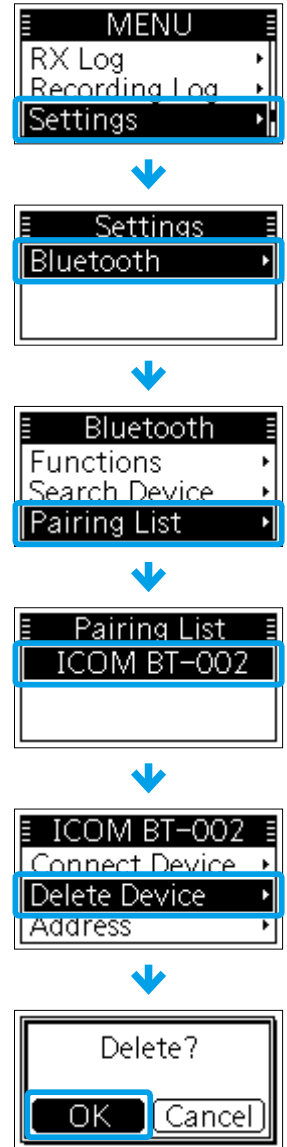
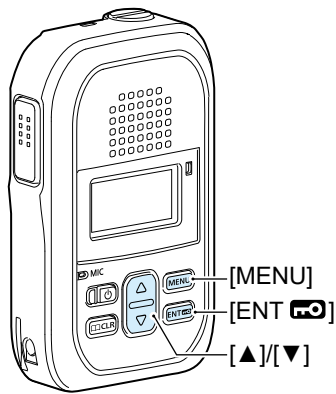







Using a Bluetooth headset

◇ Initializing the pairing list of the transceiver

If you have problems with Bluetooth operation, initialize the pairing list, as shown below.

① All the paired Bluetooth devices are deleted from the pairing list by the initialization.

1. Turn OFF the transceiver.
2. While holding down [ENT , turn ON the transceiver.
3. Release [ENT ] when the Standby screen is displayed.
4. Push [MENU].
5. Push [▲]/[▼] to select “Settings,” and then push [ENT ].
6. Push [▲]/[▼] to select “Bluetooth,” and then push [ENT ].
7. Push [▲]/[▼] to select “Initialize,” and then push [ENT ].
8. Push [▲]/[▼] to select “OK,” and then push [ENT ].
 - The pairing list is initialized.
9. Push [MENU].
 - Exits the MENU screen.

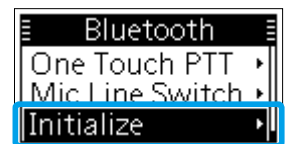
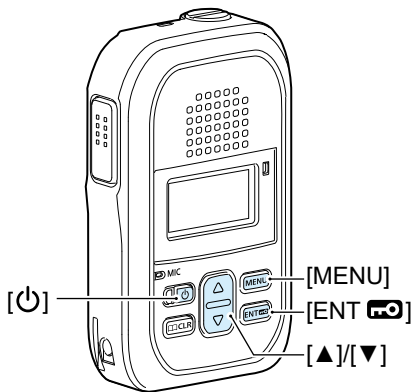

Section 6 FOR YOUR REFERENCE

Troubleshooting	6-2
Specifications	6-4
◇ IP110H.....	6-4
◇ BC-257	6-4

Troubleshooting

The following chart is designed to help you correct problems that are not equipment malfunctions. If you are unable to locate the cause of a problem or solve it through the use of this chart, contact your nearest Icom Dealer or Service Center.

Problem	Possible Cause	Solution	Reference
The transceiver does not turn ON.	The battery is exhausted.	Charge the battery.	—
No sound comes from the speaker.	The volume level is too low.	Push [▲]/[▼] to adjust the level.	p. 1-3
	The received audio is muted.	Hold down [☐ CLR] or [MENU] for 1 second to turn OFF the Mute function.	p. 3-9
Calls cannot be made.	The call-to party is wrong.	Check the call-to party.	pp. 2-4, 2-5
No reply is received.	Too far away from an Access Point. (The “📶” icon blinks.)	Move your location, then try again.	—
	The operator is away from the transceiver, or the transceiver is turned OFF.	Wait until the operator is back, or ask your system manager about the operator’s status.	—
“Key lock” is displayed when a key is pushed.	The Key Lock function is turned ON.	Hold down [ENT 📠] for 1 second to turn OFF the Key Lock function.	p. 1-6
Cannot charge the transceiver completely.	The transceiver is ON while charging.	Turn OFF the transceiver while charging.	—
	Loose the charging cable connection.	Firmly insert the charging cable.	p. 5-4
	The transceiver is not properly inserted into the charger.	Properly insert the transceiver into the charger.	p. 5-4
	The USB cables are connected to both the transceiver and the charger.	Disconnect the cables, and then connect properly.	p. 5-4
	You are using a low output AC adapter.	Use a 5 V/2 A output AC adapter.	—
The “📶” icon blinks, or “Connecting...” is displayed. (The Standby screen is not displayed.)	SSID Broadcast function is OFF in an Access Point (when the 5 GHz band is used).	Ask your system manager about the Access Point settings.	—
	Too far away from an Access Point.	Move your location, and then try again.	—
	The Access Point is turned OFF.	Turn ON the Access Point.	—

Troubleshooting

Problem	Possible Cause	Solution	Reference
Pairing failed.	The transceiver is not in the Pairing mode.	Enter the Pairing mode.	p. 5-6
	There are other active Bluetooth devices nearby.	Stop using other Bluetooth devices.	—
		Use the transceiver away from other Bluetooth devices.	—
	There are other devices that are operating in the 2.4 GHz band.	Use the transceiver away from the other devices, or stop using those devices.	—
“Pairing list is full” is displayed on the Pairing screen.	The number of paired devices exceeds the maximum number.	Delete other Bluetooth devices from the pairing list.	p. 5-9
The call was suddenly cut off. / Noise is heard.	Too far away from the Bluetooth device.	Get closer to the Bluetooth device. ① The communication range of Bluetooth is approximately 10 meters (33 feet).	—
	Electromagnetic interference from other electronic devices.	Use the transceiver away from the other devices, or stop using those devices.	—
No sound comes from the earphone that is connected to the VS-3.	The volume level is set too low.	Increase the VS-3’s volume level.	p. 5-5
		Increase the transceiver’s volume level. (When “Bluetooth Synchronous Volume” is set to valid in the Controller.)	p. 1-3
	Loose earphone plug connection.	Firmly insert the plug.	—

Specifications

◇ IP110H

General

- Operating temperature range: $-10^{\circ}\text{C} \sim +60^{\circ}\text{C}$, $14^{\circ}\text{F} \sim 140^{\circ}\text{F}$
- Humidity: Less than 95% (Without condensation)
- Dimensions: $57.0\text{ (W)} \times 96.9\text{ (H)} \times 25.1\text{ (D)}\text{ mm}$, $2.2\text{ (W)} \times 3.8\text{ (H)} \times 1.0\text{ (D)}\text{ inches}$
(Projections not included)
- Weight: Approximately 146 g, 5.2 oz
- Power supply: 3.75 V DC (Internal battery)
- IP code: IP67/IP54
- Operating time: Approximately 26.5 hours (TX : RX : Stand-by = 1 : 1 : 8)

Audio

- Codec: G.711 μ -law (64 kbps)
- AF output power:
 - Internal speaker: More than 1000 mW (at 10% distortion into an 8 Ω load)
 - External speaker: More than 300 mW (at 10% distortion into an 8 Ω load)
- AF output impedance:
 - Internal speaker: 8 Ω
 - External speaker: 8 Ω

WLAN

- Wireless LAN standard: IEEE802.11 n/a/b/g/ac
- Authentication and Encryption: WEP (64/128 bit), WPA-PSK (TKIP/AES), WPA2-PSK (TKIP/AES)
- Channels:
 - EXP version: 11 channels (2.4 GHz band)
19 channels (5 GHz band)
 - USA version: 11 channels (2.4 GHz band)
21 channels (5 GHz band)

① May differ depending on the country of use.
- Protocol: TCP/IP
- Output power (typical): Less than 10 mW/MHz

Bluetooth

- Frequency range: 2402 ~ 2480 MHz
- Transmission power: Class 2
- Version: Bluetooth Version 4.2
- Profile: HFP, HSP

◇ BC-257

- Input voltage: $5.0\text{ V} \pm 0.25\text{ V DC}$ (Used with a 5 V/2 A output AC adapter)
 $15\text{ V} \pm 0.75\text{ V DC}$ (Used with the BC-228)
- Charging temperature range: $0^{\circ}\text{C} \sim 40^{\circ}\text{C}$, $32^{\circ}\text{F} \sim 104^{\circ}\text{F}$
- Dimensions: $98.0\text{ (W)} \times 48.6\text{ (H)} \times 70.0\text{ (D)}\text{ mm}$, $3.9\text{ (W)} \times 1.9\text{ (H)} \times 2.8\text{ (D)}\text{ inches}$
(With the charger's covers)
- Weight: Approximately 94 g, 3.3 oz

① All stated specifications are subject to change without notice or obligation.

